

TRONCATRICI

per LEGNO - ALLUMINIO - PVC



GARANZIA
3
ANNI





PEGIC



Costituita nel 1960 la Ditta PEGIC da 50 ANNI costruisce troncatrici per legno, alluminio e PVC. Nel 1989 si è ristrutturata ed ha trasformato il proprio prodotto rinnovandolo con caratteristiche tecniche semplici ma innovative, che non trovano riscontro nella concorrenza, fornendo all'utilizzatore una macchina precisa nel tempo ed affidabile. All'interno dell'azienda vengono svolte tutte le lavorazioni meccaniche sui ns. Centri di lavoro ed il montaggio completo. La costruzione artigianale ed il collaudo di ogni singola macchina la rendono: **SEMPLICE NELL'UTILIZZO, NELLA MANUTENZIONE E NELLE RIPARAZIONI** Con ricambi sempre pronti (spediti entro le 24 ore senza minini di fatturazione). Da sempre attenti alla qualità la ns. società in questi anni ha continuamente apportato Modifiche e migliorie ai propri prodotti dando risposte innovative e molte volte copiate dalla concorrenza, **PRECISE, ROBUSTE, VERSATILI** le troncatrici PEGIC sono sinonimo di precisione e Qualità, i vantaggi tecnici sono apprezzati dai ns. clienti falegnami e sono un vanto per la ns. società (come si può leggere sui vari forum).

VANTAGGI RISPETTO ALLA CONCORRENZA :

- **PIANO SUPERIORE SOLLEVATO CON INGRANAGGI IN ACCIAIO (10 ANNI DI GARANZIA)**
- **PROFILO BREVETTATO IN ALLUMINIO CHE IMPEDISCE AI PICCOLI PEZZI DI LEGNO DI INCASTRARSI E ROMPERE LA LAMA O GLI APPOGGI DX E SX**
- **FUSIONI IN ALLUMINIO NON PRESSOFUSO CON SPESSORI MINIMI DI 5 MM.**
- **COLLAUDO DI TUTTE LE MACCHINE CON TAGLIO DEL LEGNO**
- **POTENZA DEI MOTORI REALI**
- **3 ANNI DI GARANZIA SU MECCANICA E PARTI ELETTRICHE**

Founded in 1960, PEGIC has been manufacturing cutting-off machines for wood, aluminum and PVC for the past 50 YEARS. In 1989, the company underwent a restructuring and converted its production by renewing it with simple but innovative technical characteristics that are not found in the competition and which provide the users with precise, robust and reliable over time. All the mechanical machining work is done in-house in our machining centers, as is full assembly. Craftsmen's care and attention to detail ensure that the machines are: EASY TO USE, SERVICEABLE AND DURABLE. Spare parts are always available (shipped within 24 hours and no minimum order). Our company has always paid special attention to quality and over the years our machines have been modified and improved so as to provide innovative answers to the needs of our customers, often setting standards that are copied by our competitors. PEGIC is PRECISE, DURABLE AND VERSATILE, a synonym for accuracy and reliability. The features of our machines are much appreciated by our carpenters and are a source of pride for our company (confirmed in many forums).

BENEFITS OVER THE COMPETITION:

- **RAISED UPPER BED WITH STEEL GEARING (10-YEAR WARRANTY)**
- **PATENTED ALUMINUM PROFILE THAT PREVENTS SMALL PIECES OF WOOD FROM GETTING STUCK AND BREAKING THE BLADE OR LEFT AND RIGHT SIDE SUPPORTS**
- **ALUMINUM ALLOY CASTINGS AT LEAST 5 MM THICK, NOT DIE CAST**
- **THOROUGH TESTING OF ALL MACHINES WITH WOOD CUTTING**
- **REAL MOTOR POWER RATINGS**
- **3-YEAR WARRANTY ON MECHANICAL AND ELECTRICAL PARTS**

C P E G



machines for wood, aluminum
at a restructuring process and
ative features, none of which
machines that remain precise
s performed in-house on our
e tests to which every product
VICE AND REPAIR with spare
imum order limitation). Our
the years the products have
ers to the customers' needs,
GIC cutting-off machines are
y and quality. The technical
er customers and are a source

NTY)
ES OF WOOD FROM JAMMING
ORTS
E CAST
NG TRIALS

S



INDICE	PAG.
• R 300 SI	4
• F 315 SI	6
• ECOM 14 - ECOM 300	8
• F 10 - F 14	10
• GP 350 RT	12
• GP 300 RT	14
• 350 CORNICI	16
• 300 CORNICI	18
• DIAMANT 10 - GPS	20
• OPTIONAL	22



SQUADRETTA SCORREVOLE
per un maggior appoggio in ingresso.
SLIDING BRACKET
For a better support in entrance.



SQUADRETTA
con possibilità di fare tagli a 45°
della lunghezza desiderata.
STAINLESS STEEL BRACKET
with the possibility of cutting at 45°
of the desired length.

BLOCCAGGIO SQUADRETTA
rigidissimo e regolabile
STAINLESS STEEL BRACKET LOCK
extra rigid and adjustable

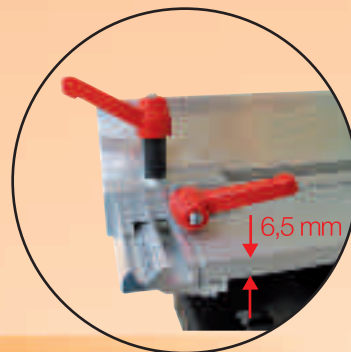

PIANETTO
rigidissimo
6,5 mm spessore
ARCH
extra-rigid
6.5 mm thickness

R 300 SI

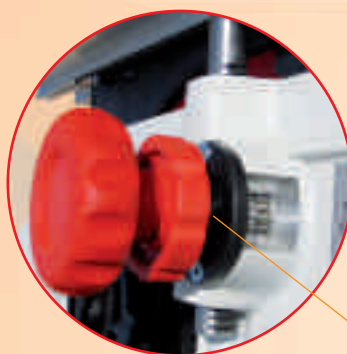

PIGNONE E CREMAGLIERA
in acciaio. **Garanzia 10 anni.**
PINION AND RATCHET
made in steel.
10 years warranty.

R 300 S



R 300 I



VERSIONE SENZA PIANETTO
ARCHLESS VERSION

R 300



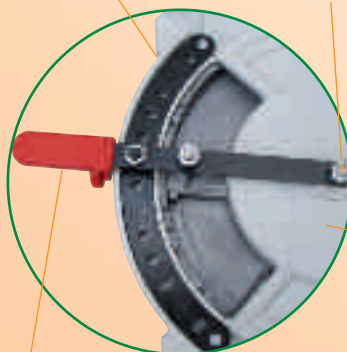

INSERTO gradi in acciaio,
massima durata e precisione
nel tempo. **Garanzia 5 anni.**
INSERT steel grades.
Maximum duration and
precision even after years.
5 years warranty.

CUSCINETTO
BEARING



LEVA per gradi in acciaio,
con cuscinetto. **Garanzia 5 anni.**
LEVER for grades made in steel,
with bearing. 5 years warranty.

MOD.	PESO WEIGHT	POTENZA MOTORE REALE KW REAL ENGINE POWER
R 300 SI	 Kg=23	 1= Kw 1,1 - 3= Kw 1,3

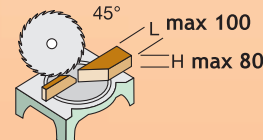
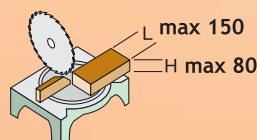

valori in mm
mm values

PEGIC PEGI



AMMORTIZZATORE
 con molla a compressione pretemperata (mantiene la stessa forza anche dopo anni) è tensionabile, no manutenzione, **garanzia 5 anni.**
SHOCK-ABSORBER
 with compressed pretempered spring (it maintains the same strenght even after years) it's tensionable. No maintenance required. **5 years warranty.**



SNODO
 con cuscinetto, massima scorrevolezza e rigidità. No manutenzione, **garanzia 5 anni.**
COUPLING
 with bearing, maximum fluency and rigidity. No maintenance required. **5 years warranty.**



VERSIONE ALLUMINIO con morsa manuale e lama per alluminio. **PER MODELLI: R 300 SI - R 300 S - R 300 I - R 300**
ALLUMINIUM VERSION with manual clamp and aluminium blade. **FOR MODELS: R300 SI - R 300 S - R 300 I - R 300**

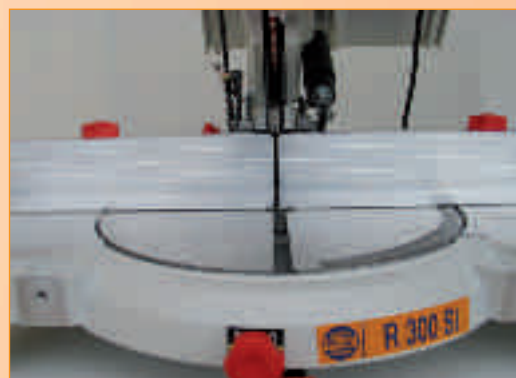

ESCLUSIVA PEGIC BREVETTATO
 impedisce il passaggio di piccoli pezzi di legno e alluminio, evitando la rottura degli appoggi DX e SX e della lama.
EXCLUSIVE PATENTED PEGIC
 it blocks small pieces of wood and aluminium, avoiding the break of the blade and the left and the right supports.

OPTIONAL:

- 1
- 3
- 6
- 7
- 10
- 11



GIRI MINUTO m/1'	Ø	IMBALLO PACKING
3000	Ø300 x 30 x 2,8	H= 53 A= 71 B= 57

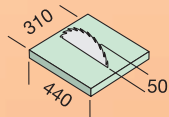
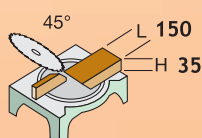
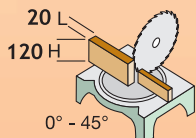



SQUADRETTA SCORREVOLE
per un maggior appoggio in ingresso.
SLIDING BRACKET
For a better support in entrance.



SQUADRETTA
con possibilità di fare tagli a 45°
della lunghezza desiderata.
STAINLESS STEEL BRACKET
with the possibility of cutting at 45°
of the desired length.

BLOCCAGGIO SQUADRETTA
rigidissimo e regolabile
STAINLESS STEEL BRACKET LOCK
extra rigid and adjustable

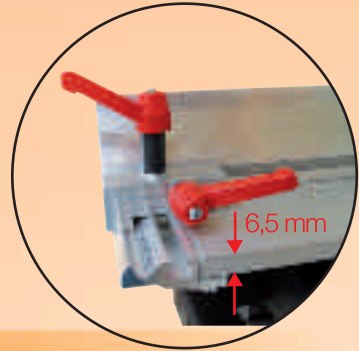

PIANETTO
rigidissimo
6,5 mm spessore
ARCH
extra-rigid
6.5 mm thickness

F 315 SI



PIGNONE E CREMAGLIERA
in acciaio. **Garanzia 10 anni**
PINION AND RATCHET
made in steel.
10 years warranty.

INSERTO gradi in acciaio,
massima durata e precisione
nel tempo. **Garanzia 5 anni**
INSERT steel grades.
Maximum duration and
precision even after years.
5 years warranty

CUSCINETTO
BEARING

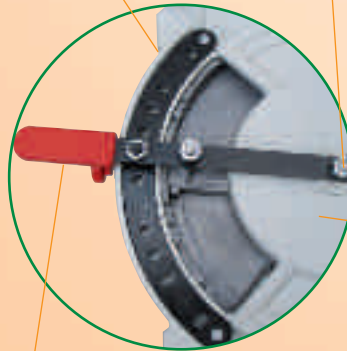

LEVA per gradi in acciaio,
con cusc inetto. **Garanzia 5 anni**
LEVER for grades made in steel,
with bearing. 5 years warranty

F 315 S



F 315 I



F 315



MOD.	PESO WEIGHT	POTENZA MOTORE REALE KW REAL ENGINE POWER
F 315 SI	 Kg=23	 1= Kw 1,1 - 3= Kw 1,3

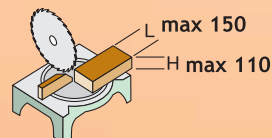

valori in mm
mm values

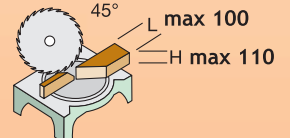

PEGIC PEGI

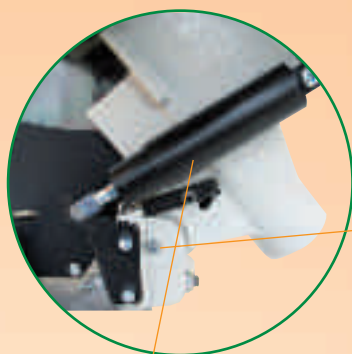

AMMORTIZZATORE
 con molla a compressione pretemperata (mantiene la stessa forza anche dopo anni) è tensionabile, no manutenzione, **garanzia 5 anni.**
SHOCK-ABSORBER
 with compressed pretempered spring (it maintains the same strength even after years) it's tensionable. No maintenance required. **5 years warranty.**

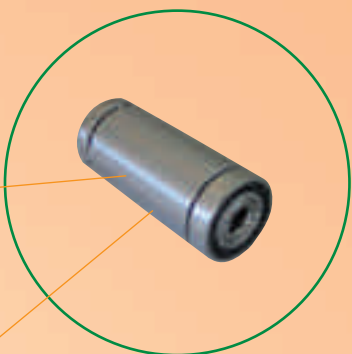

SNODO
 con cuscinetto, massima scorrevolezza e rigidità. No manutenzione, **garanzia 5 anni**
COUPLING
 with bearing, maximum fluency and rigidity. No maintenance required. **5 years warranty.**

NEW

 **3600**
 giri minuto

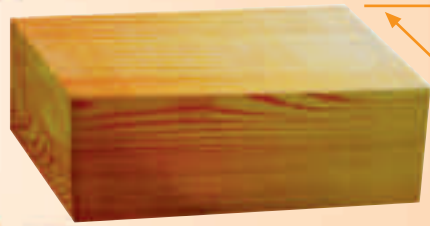
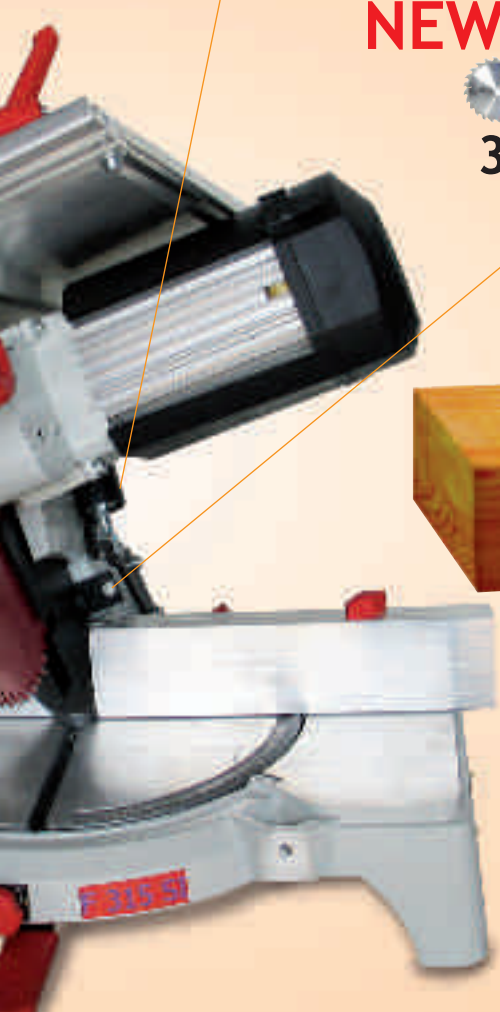

L 155 mm
 L 135 mm
 H 100 mm
 H 110 mm



VERSIONE ALLUMINIO con morsa manuale e lama per alluminio.
PER MODELLI: F 315 SI
ALUMINIUM VERSION with manual clamp and aluminium blade.
FOR MODELS: F 315 SI

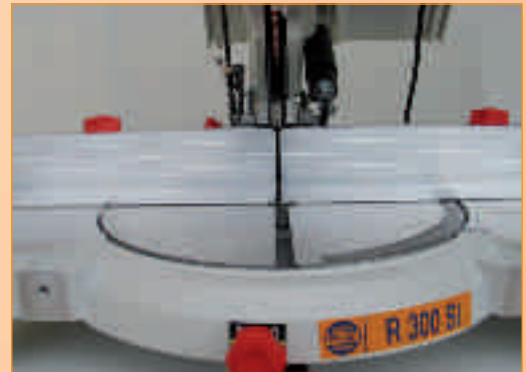



OPTIONAL:

- 1
- 3
- 6
- 7
- 10
- 11

ESCLUSIVA PEGIC BREVETTATO impedisce il passaggio di piccoli pezzi di legno e alluminio, evitando la rottura degli appoggi DX e SX e della lama.
EXCLUSIVE PATENTED PEGIC it blocks small pieces of wood and aluminium, avoiding the break of the blade and the left and the right supports.



GIRI MINUTO m/1'	Ø	IMBALLO PACKING
 3600	 Ø315 x 30 x 3,2	 H= 53 A= 71 B= 57

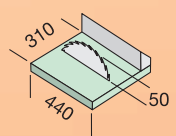
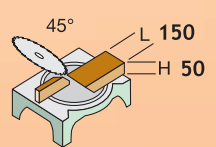



SQUADRETTA SCORREVOLE
per un maggior appoggio in ingresso.
SLIDING BRACKET
For a better support in entrance.



SQUADRETTA
con possibilità di fare tagli a 45° della lunghezza desiderata.
STAINLESS STEEL BRACKET
with the possibility of cutting at 45° of the desired length.

BLOCCAGGIO SQUADRETTA
rigidissimo e regolabile
STAINLESS STEEL BRACKET LOCK
extra rigid and adjustable

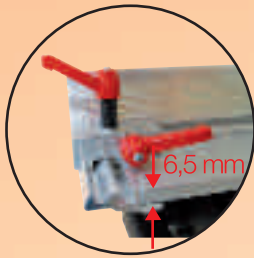

PIANETTO
rigidissimo
6,5 mm spessore
ARCH
extra-rigid
6.5 mm thickness

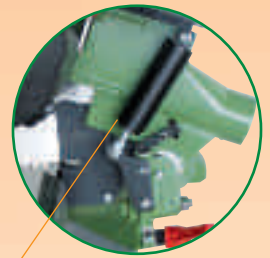

AMMORTIZZATORE
con molla a compressione pretemperata (mantiene la stessa forza anche dopo anni) è tensionabile,
no manutenzione, **garanzia 5 anni.**
SHOCK-ABSORBER
with compressed pretempered spring (it maintains the same strenght even after years) it's tensionable. No maintenance required. 5 years warranty.

ECOM 14

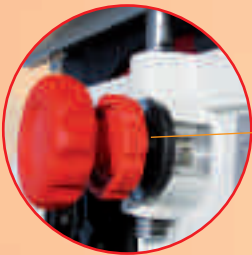
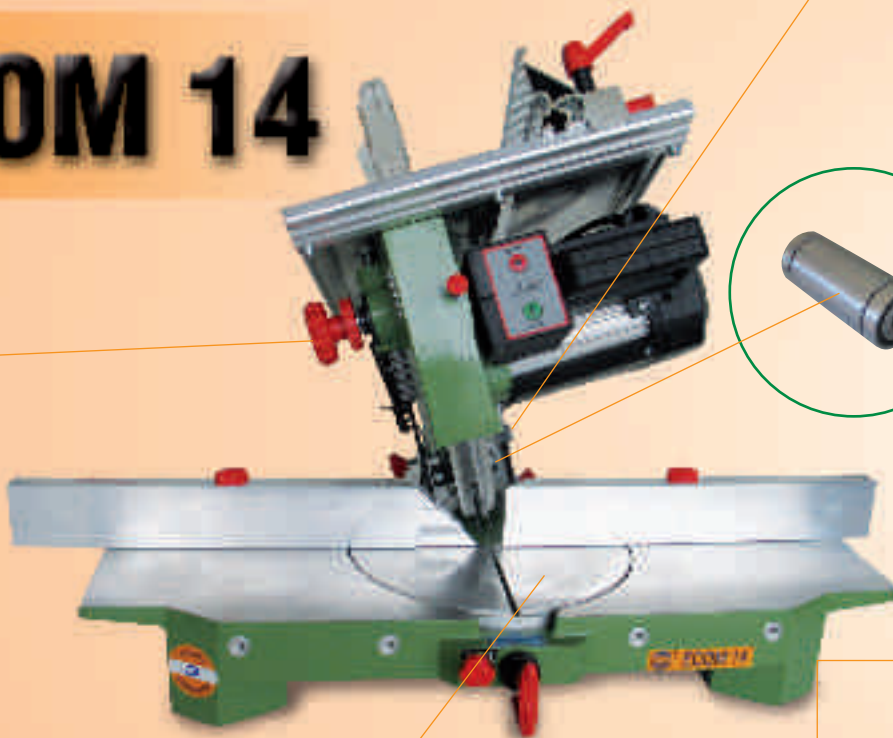

PIGNONE E CREMAGLIERA
in acciaio. **Garanzia 10 anni**
PINION AND RATCHET
made in steel. 10 years warranty.

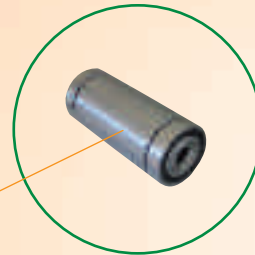

SNODO
con cuscinetto, massima scorrevolezza e rigidità.
No manutenzione, **garanzia 5 anni**
COUPLING
with bearing, maximum fluency and rigidity. No maintenance required. 5 years warranty.

OPTIONAL:

- | | | | |
|---|----|----|---|
| 1 | 4 | 5 | 6 |
| 7 | 10 | 11 | |

ECOMEC 14



Tutti i movimenti sono dotati di **CUSCINETTI** che danno scorrevolezza, rigidità e precisione e sono privi di manutenzione. **Garanzia 5 anni.**
All the movements are provided of BEARINGS which give fluency, rigidity and precision. The maintenance is not required. 5 years warranty.



VERSIONE ALLUMINIO con morsa manuale e lama per alluminio. **PER MODELLI: ECOM 14 - ECOMEC14 - ALLUMINIUM VERSION** with manual clamp and aluminium blade. **FOR MODELS: ECOM 14 - ECOMEC14**

MOD.	PESO WEIGHT	POTENZA MOTORE REALE KW REAL ENGINE POWER	GIRI MINUTO m/1'	Ø	IMBALLO PACKING
ECOM 14	 Kg=28	 1= Kw 1,1 - 3= Kw 1,3	 3000	 Ø300 x 30 x 3,2	 H= 55 A= 78 B= 66

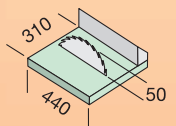
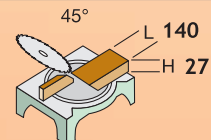
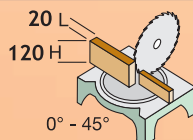
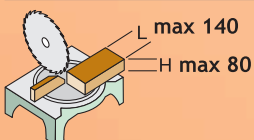

valori in mm - mm values

PEGI PEGI



SQUADRETTA SCORREVOLE
per un maggior appoggio in ingresso.
SLIDING BRACKET
For a better support in entrance.



SQUADRETTA
con possibilità di fare tagli a 45° della lunghezza desiderata.
STAINLESS STEEL BRACKET
with the possibility of cutting at 45° of the desired length.

BLOCCAGGIO SQUADRETTA
rigidissimo e regolabile
STAINLESS STEEL BRACKET LOCK
extra rigid and adjustable

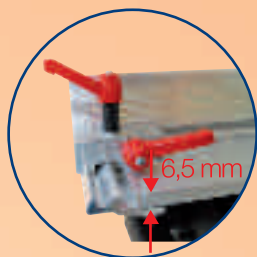

PIANETTO
rigidissimo
6,5 mm spessore
ARCH
extra-rigid
6.5 mm thickness

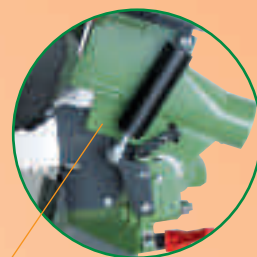

AMMORTIZZATORE
con molla a compressione pretemperata (mantiene la stessa forza anche dopo anni) è tensionabile, no manutenzione, **garanzia 5 anni.**
SHOCK-ABSORBER
with compressed pretempered spring (it maintains the same strenght even after years) it's tensionable.
No maintenance required. 5 years warranty.

ECOM 300

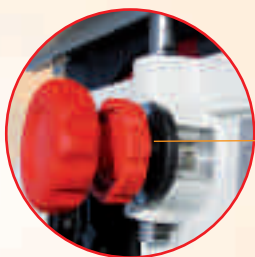

PIGNONE E CREMAGLIERA
in acciaio. **Garanzia 10 anni**
PINION AND RATCHET
made in steel. 10 years warranty.

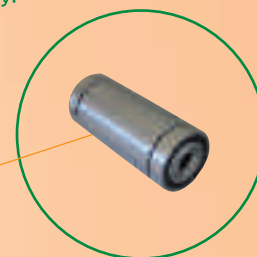
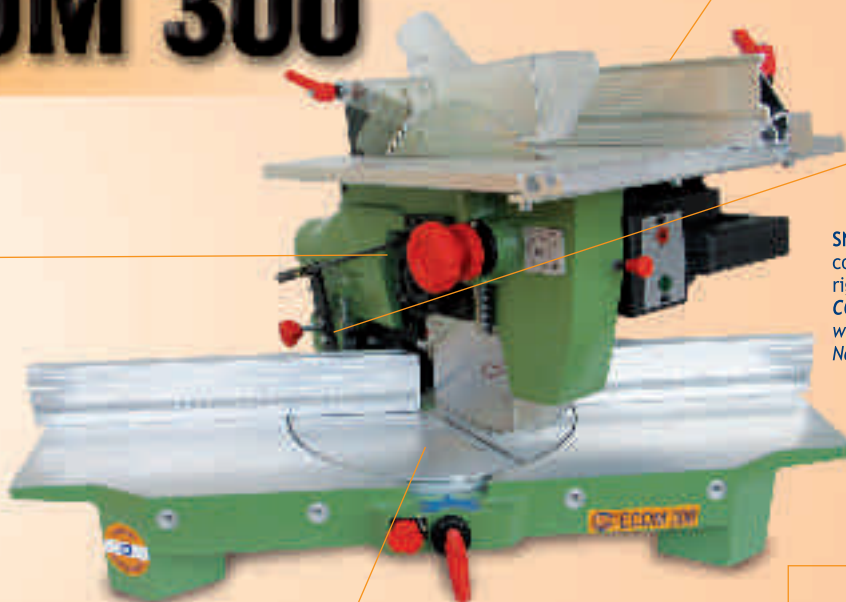

SNODO
con cuscinetto, massima scorrevolezza e rigidità. No manutenzione, **garanzia 5 anni**
COUPLING
with bearing, maximun flucny and rigidity.
No maintenance required. 5 years warranty.

OPTIONAL:

- | | | | |
|---|----|----|---|
| 1 | 4 | 5 | 6 |
| 7 | 10 | 11 | |

ECOM 300

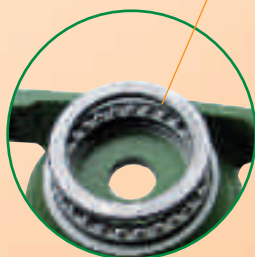

Tutti i movimenti sono dotati di **CUSCINETTI** che danno scorrevolezza, rigidità e precisione e sono privi di manutenzione. **Garanzia 5 anni.**
*All the movements are provided of **BEARINGS** which give flucny, rigidity and precision. The maintenance is not required. 5 years warranty.*



VERSIONE ALLUMINIO con morsa manuale e lama per alluminio. **PER MODELLI: ECOM 14 - ECOMEC14 - ALLUMINIUM VERSION** with manual clamp and aluminium blade. **FOR MODELS: ECOM 14 - ECOMEC14**

MOD.	PESO WEIGHT	POTENZA MOTORE REALE KW REAL ENGINE POWER	GIRI MINUTO m/1'	Ø	IMBALLO PACKING
ECOM 300	 Kg=28	 1= Kw 1,1 - 3= Kw 1,3	 3000	 Ø300 x 30 x 3,2	 H= 55 A= 78 B= 66

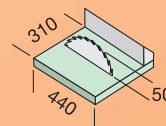
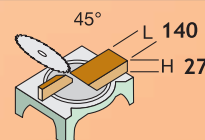
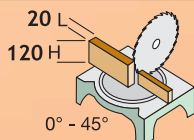
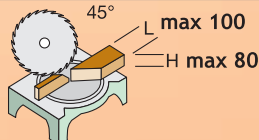
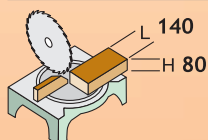

valori in mm - mm values

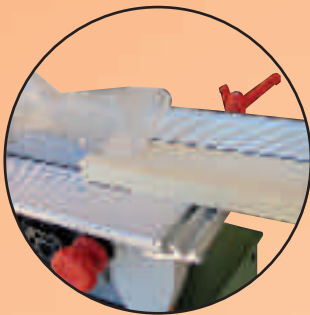

SQUADRETTA SCORREVOLE
per un maggior appoggio in
ingresso.
SLIDING BRACKET
For a better support in entrance.



SQUADRETTA
con possibilità di fare tagli a 45°
della lunghezza desiderata.
STAINLESS STEEL BRACKET
with the possibility of cutting at
45° of the desired length.

**BLOCCAGGIO
SQUADRETTA**
rigidissimo e
regolabile
**STAINLESS STEEL
BRACKET LOCK**
extra rigid and
adjustable

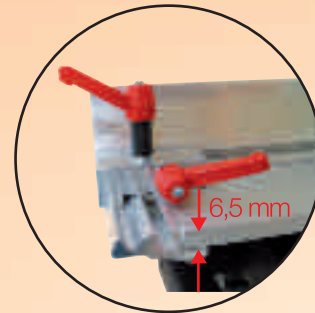

PIANETTO
rigidissimo
6,5 mm spessore
ARCH
extra-rigid
6.5 mm thickness

F 10

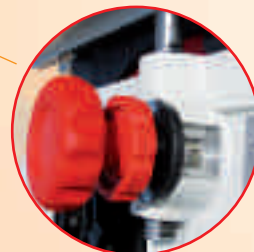

PIGNONE E CREMAGLIERA
in acciaio. **Garanzia 10 anni**
PINION AND RATCHET
made in steel. **10 years**
warranty.



Tutti i movimenti sono dotati di
CUSCINETTI che danno scorrevolezza,
rigidità e precisione e sono privi di
manutenzione. **Garanzia 5 anni.**
All the movements are provided of
BEARINGS which give fluency, rigidity
and precision.
The maintenance is not required.
5 years warranty.

OPTIONAL:

- 1
- 4
- 6
- 7
- 10

MOD.	PESO WEIGHT	POTENZA MOTORE REALE KW REAL ENGINE POWER	GIRI MINUTO m/1'	Ø	IMBALLO PACKING
F 10 CE	Kg=31	1= Kw 1,5 - 3= Kw 1,8	3000	Ø250 x 30 x 3,2	H= 55 A= 78 B= 66

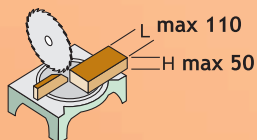

valori in mm - mm values

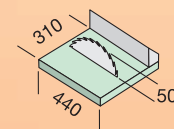
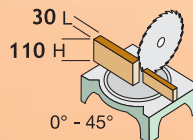
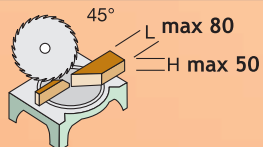

PEGIC PEGI



SQUADRETTA SCORREVOLE
per un maggior appoggio in ingresso.
SLIDING BRACKET
For a better support in entrance.



SQUADRETTA
con possibilità di fare tagli a 45° della lunghezza desiderata.
STAINLESS STEEL BRACKET LOCK
with the possibility of cutting at 45° of the desired length.

BLOCCAGGIO SQUADRETTA
rigidissimo e regolabile
STAINLESS STEEL BRACKET LOCK
extra rigid and adjustable

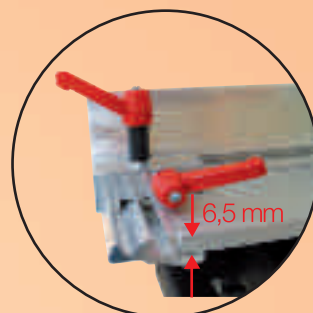

PIANETTO
rigidissimo
6,5 mm spessore
ARCH
extra-rigid
6.5 mm thickness

F 14

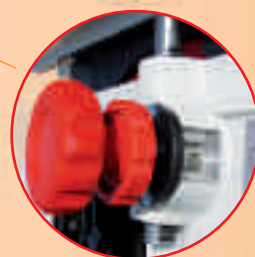

PIGNONE E CREMAGLIERA
in acciaio. **Garanzia 10 anni**
PINION AND RATCHET
made in steel. **10 years warranty.**

OPTIONAL:

- 1 4 6 7 10

F 14 PARTICOLARE

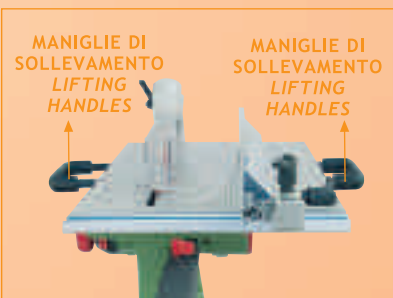

Tutti i movimenti sono dotati di **CUSCINETTI** che danno scorrevolezza, rigidità e precisione e sono privi di manutenzione.
Garanzia 5 anni.
All the movements are provided of BEARINGS which give fluency, rigidity and precision. The maintenance is not required. 5 years warranty.

MOD.	PESO WEIGHT	POTENZA MOTORE REALE KW REAL ENGINE POWER	GIRI MINUTO m/1'	Ø	IMBALLO PACKING
F 14 CE	Kg=39	1= Kw 1,7 - 3= Kw 2	3000	Ø300 x 30 x 3,2	H= 67 A= 73 B= 70

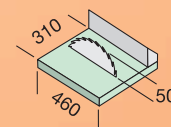
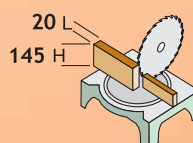
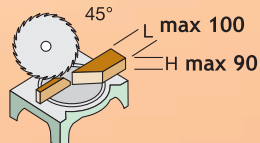
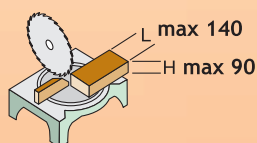



PEGIC P

DOPPIO AMMORTIZZATORE
permette di abbassare la testa
porta lama senza alcuno sforzo.

Garanzia 5 anni.

DOUBLE SHOCK-ABSORBER
it allows to bring down the head
blade holder without any effort.
5 years warranty.



PROTEZIONE LAMA
con cuscinetto
BLADE PROTECTION
with bearing

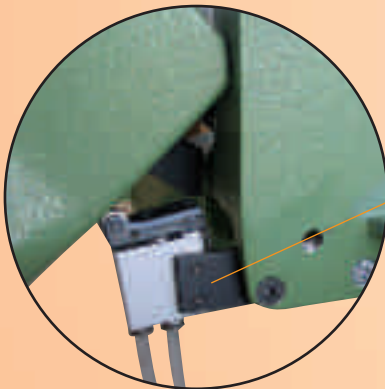

MICROVALVOLA
per apertura e chiusura morse
MICROVALVE
for the opening and the closing
of the clamps

COPIE OPTIONAL DI MORSE PNEUMATICHE
OPTIONAL COUPLE OF PNEUMATIC CLAMPS

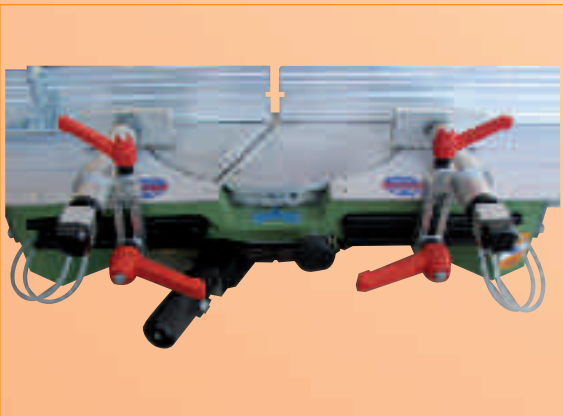

GP 350 RT

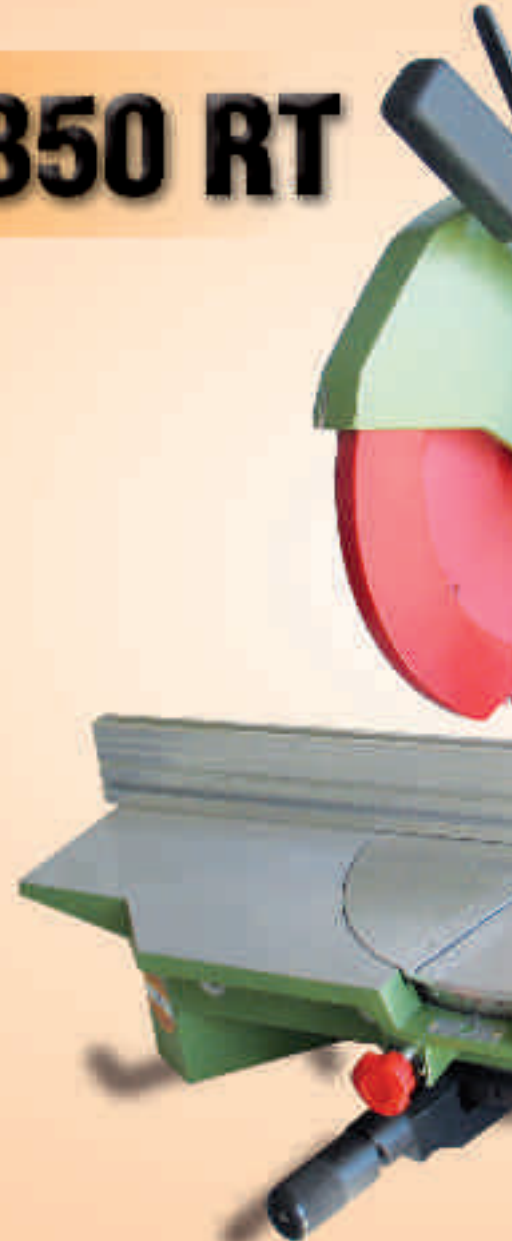

MOD.	PESO WEIGHT	POTENZA MOTORE REALE KW REAL ENGINE POWER
GP 350 RT	 Kg= 52	 1= Kw 2,00 - 3= Kw 2,00

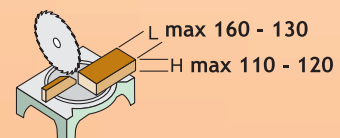

valori in mm - mm values

TRONCATRICI per LEGNO - ALLUMINIO - P.V.C. - LEGHE LEGGERE

PEGIC PEGI

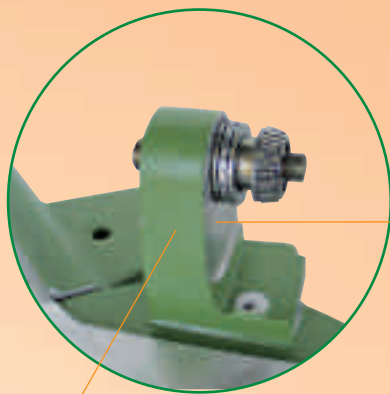
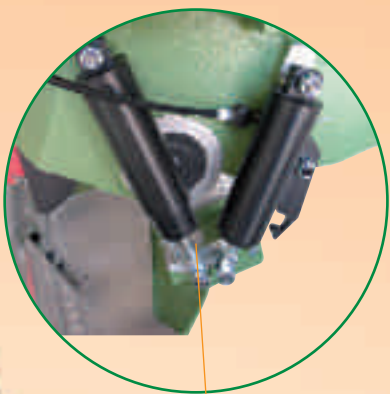

Tutti i movimenti sono dotati di CUSCINETTI che danno scorrevolezza, rigidità e precisione e sono privi di manutenzione. Garanzia 5 anni.
 All the movements are provided of BEARINGS which give fluency, rigidity and precision. The maintenance is not required. 5 years warranty.

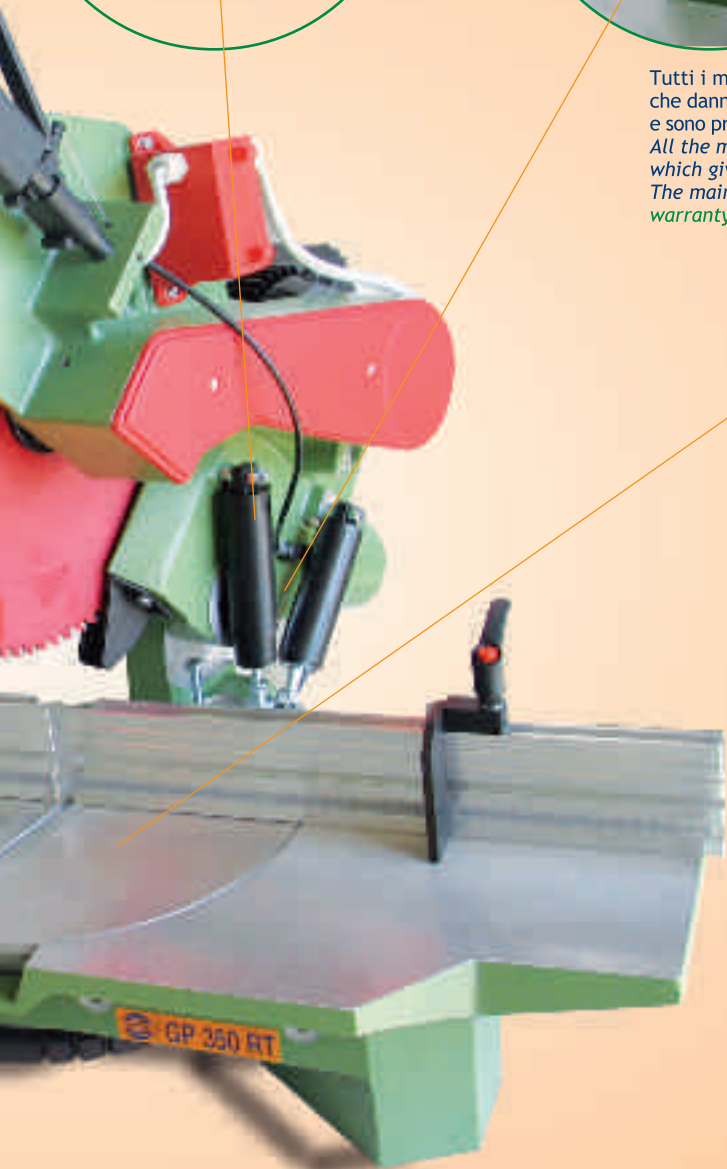

VERSIONE ALLUMINIO
 PER MODELLI: GP 350 RT - GP 300 RT
 ALLUMINIUM VERSION
 FOR MODELS: GP 350 RT - GP 300 RT

OPTIONAL:

OPTIONAL MORSA MANUALE
 OPTIONAL MANUAL CLAMP

4

5

5A

6

7

9



GIRI MINUTO m/1'

Ø

IMBALLO
 PACKING



3000

Ø350 x 30 x 3,5

H= 63 A= 97 B= 54

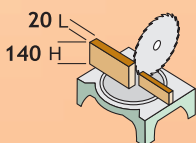
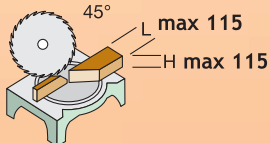



PEGIC P

DOPPIO AMMORTIZZATORE
permette di abbassare la testa
porta lama senza alcuno sforzo.

Garanzia 5 anni.

DOUBLE SHOCK-ABSORBER
it allows to bring down the head
blade holder without any effort.
5 years warranty.



PROTEZIONE LAMA
con cuscinetto
BLADE PROTECTION
with bearing

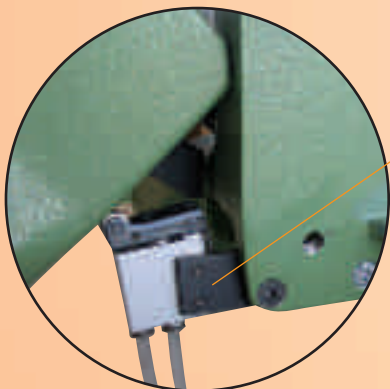

MICROVALVOLA
per apertura e chiusura morse
MICROVALVE
for the opening and the closing
of the clamps

GP 300 RT



COPPIE OPTIONAL DI MORSE PNEUMATICHE
OPTIONAL COUPLE OF PNEUMATIC CLAMPS



MOD.	PESO WEIGHT	POTENZA MOTORE REALE KW REAL ENGINE POWER
GP 300 RT €	 Kg= 52	 1= Kw 2,00 - 3= Kw 2,00

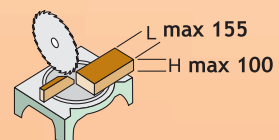

valori in mm - mm values

TRONCATRICI per LEGNO - ALLUMINIO - P.V.C. - LEGHE LEGGERE

PEGI PEGI

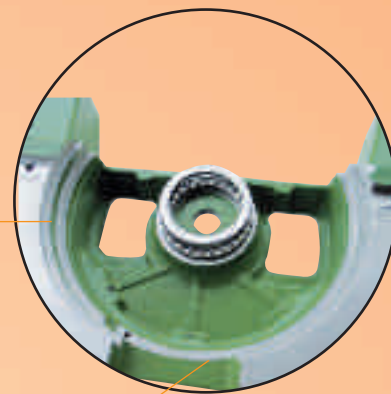
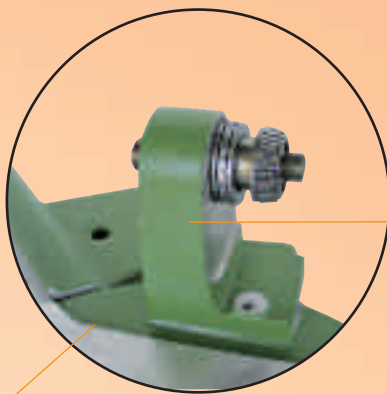
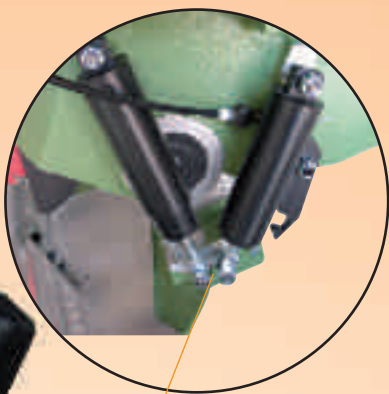

Tutti i movimenti sono dotati di **CUSCINETTI** che danno scorrevolezza, rigidità e precisione e sono privi di manutenzione. **Garanzia 5 anni.**
*All the movements are provided of **BEARINGS** which give fluency, rigidity and precision. The maintenance is not required. **5 years warranty.***

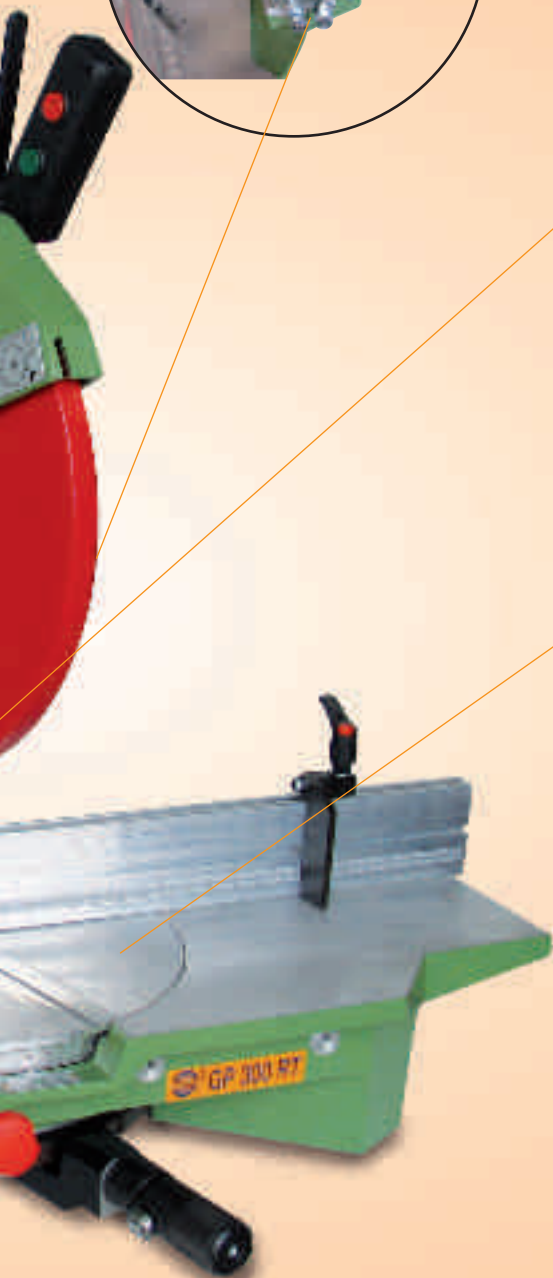





VERSIONE ALLUMINIO
PER MODELLI: GP 350 RT - GP 300 RT
ALLUMINIUM VERSION
FOR MODELS: GP 350 RT - GP 300 RT

OPTIONAL:

OPTIONAL MORSA MANUALE
OPTIONAL MANUAL CLAMP

- 4
- 5
- 5A
- 6
- 7
- 9

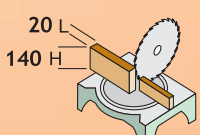

GIRI MINUTO m/1'	Ø	IMBALLO PACKING
 3000	 Ø350 x 30 x 3,2	 H= 63 A= 97 B= 54
		

350 cornici



PROTEZIONE LAMA
con cuscinetto
BLADE PROTECTION
with bearing

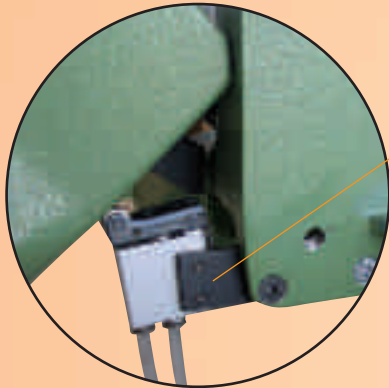

MICROVALVOLA
per apertura e chiusura morse
MICROVALVE
for the opening and the closing
of the clamps

OPTIONAL

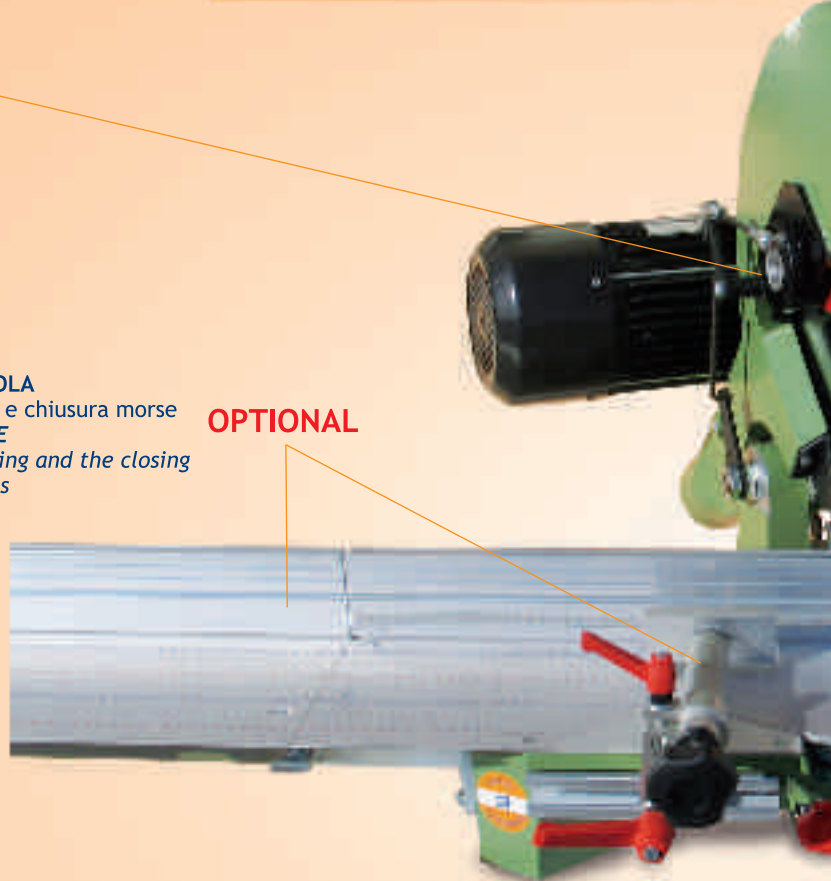



SX



PIANI



COPPIE OPTIONAL DI MORSE PNEUMATICHE
OPTIONAL COUPLE OF PNEUMATIC CLAMPS

MOD.	PESO WEIGHT	POTENZA MOTORE REALE KW REAL ENGINE POWER
350 CORNICI €		
	Kg= 52	1= Kw 2,00 - 3= Kw 2,00



PEGI PEGI

DOPPIO AMMORTIZZATORE
permette di abbassare la testa
porta lama senza alcuno sforzo.

Garanzia 5 anni.

DOUBLE SHOCK-ABSORBER
it allows to bring down the head
blade holder without any effort.
5 years warranty.

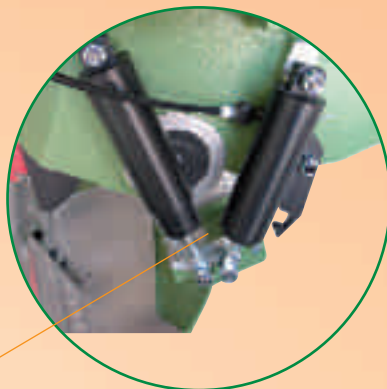

Tutti i movimenti sono dotati di **CUSCINETTI**
che danno scorrevolezza, rigidità e
precisione e sono privi di manutenzione.

Garanzia 5 anni.

All the movements are provided of **BEARINGS**
which give fluency, rigidity and precision.
The maintenance is not required. 5 years
warranty.

OPTIONAL



OPTIONAL:

12 10

DX

PLANS



GIRI MINUTO m/1'

Ø

**IMBALLO
PACKING**



3000

Ø350 x 30 x 3,5

H= 63 A= 97 B= 54

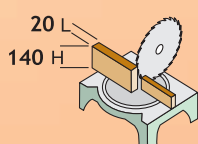
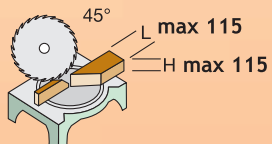

**OPTIONAL MORSA MANUALE
OPTIONAL MANUAL CLAMP**

300 cornici



PROTEZIONE LAMA
con cuscinetto
BLADE PROTECTION
with bearing

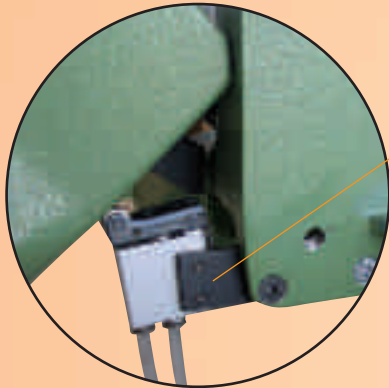

MICROVALVOLA
per apertura e chiusura morse
MICROVALVE
for the opening and the closing
of the clamps

OPTIONAL

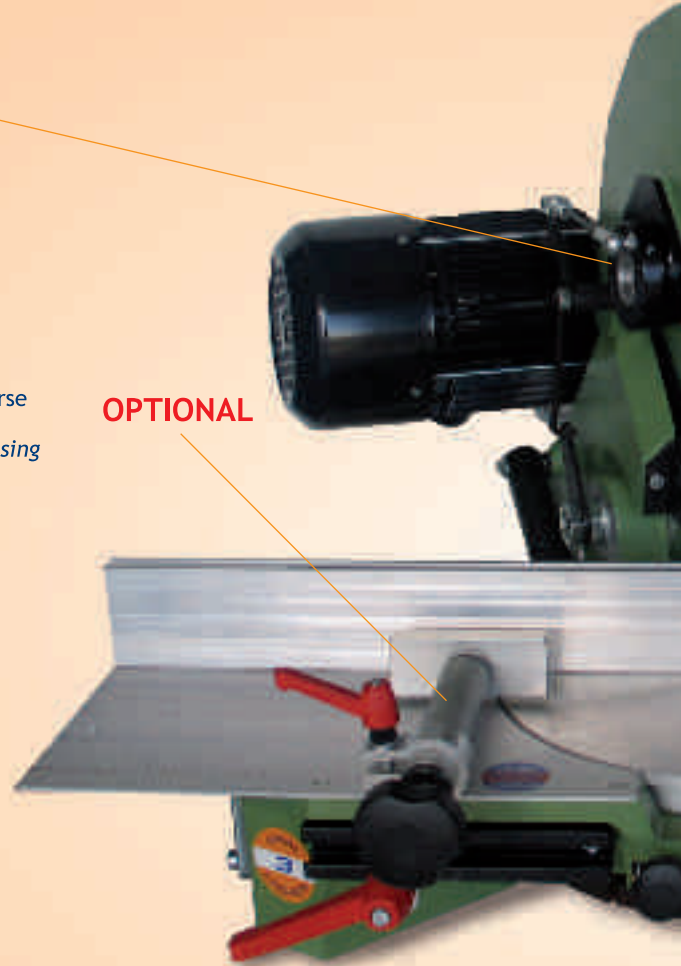

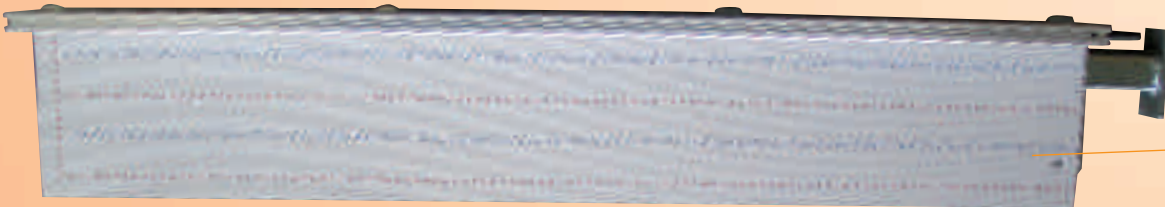

SX



PIANI



COPPIE OPTIONAL DI MORSE PNEUMATICHE
OPTIONAL COUPLE OF PNEUMATIC CLAMPS

MOD.	PESO WEIGHT	POTENZA MOTORE REALE KW REAL ENGINE POWER
300 CORNICI CE		
	Kg= 52	1= Kw 2,00 - 3= Kw 2,00



PEGGIC PEGGIC

DOPPIO AMMORTIZZATORE
permette di abbassare la testa
porta lama senza alcuno sforzo.

Garanzia 5 anni.

DOUBLE SHOCK-ABSORBER
it allows to bring down the head
blade holder without any effort.
5 years warranty.

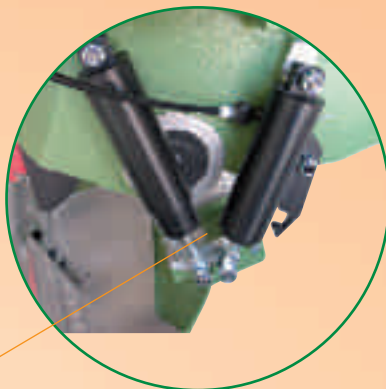

Tutti i movimenti sono dotati di **CUSCINETTI**
che danno scorrevolezza, rigidità e
precisione e sono privi di manutenzione.

Garanzia 5 anni.

All the movements are provided of **BEARINGS**
which give fluency, rigidity and precision.
The maintenance is not required. 5 years
warranty.

OPTIONAL

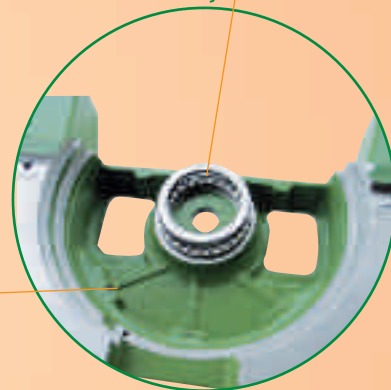

OPTIONAL:

12 10

DX

PLANS



GIRI MINUTO m/1'

Ø

**IMBALLO
PACKING**



3000

Ø350 x 30 x 3,2

H= 63 A= 97 B= 54

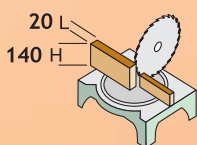

**OPTIONAL MORSA MANUALE
OPTIONAL MANUAL CLAMP**





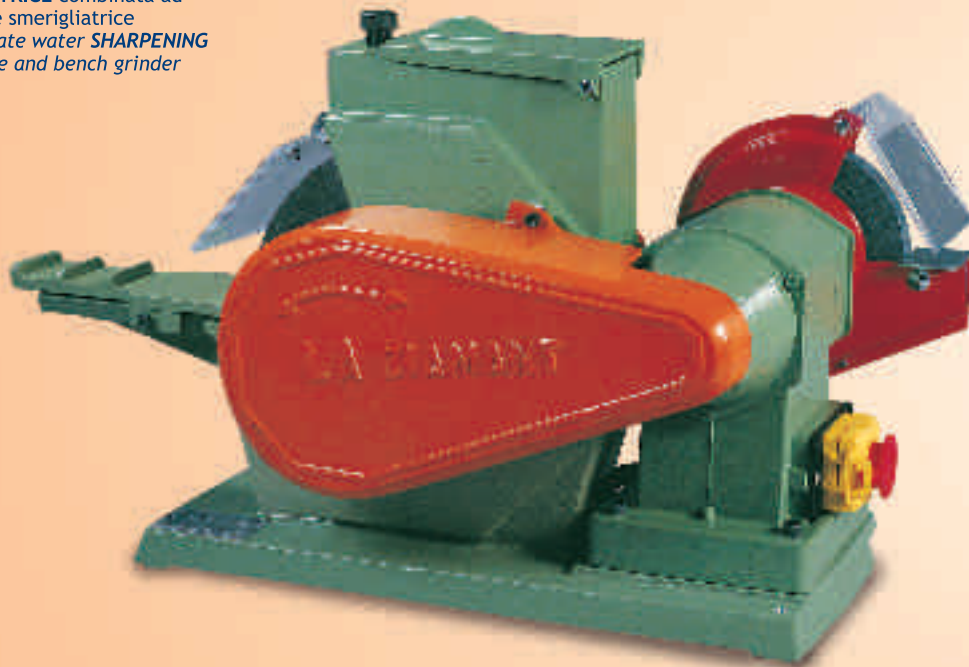

DIAMANT10

AFFILATRICE combinata ad acqua e smerigliatrice
combinata water SHARPENING
machine and bench grinder



OPTIONAL:

2

MOD.	PESO WEIGHT	POTENZA MOTORE REALE KW REAL ENGINE POWER	Ø	Ø	IMBALLO PACKING
DIAMANT 10 	 Kg=28	 1= Kw 1,2 - 3= Kw 1,4	 150x16x20	 250x25x50	 H= 40 A= 78 B= 40

GPS

BASE aspirante mod GPS
DUST collector mod.GPS



OPTIONAL:

10A

MOD.	PESO WEIGHT	POTENZA MOTORE REALE KW REAL ENGINE POWER	Ø		IMBALLO PACKING
GPS	 Kg=48	 1= Kw 1,1 - 3= Kw 1,3	 80 mm	 1200 m ³ /h	 H= 88 A= 65 B= 39



1
- TAVOLINO PIEGHEVOLE PORTATILE
- PORTABLE FOLDING TABLE

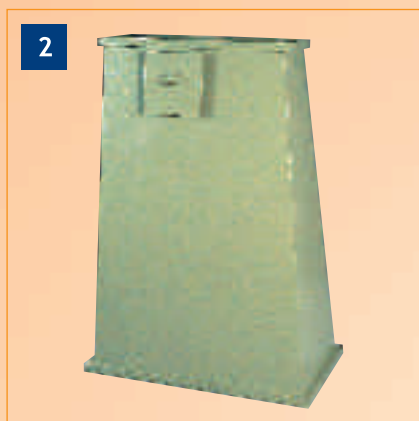

2
- BASE MOLA AD ACQUA CON VASCHETTA
- SUPPORT BENCH FOR COMBINED WATER
SHARPENING WITH SMALL BASIN

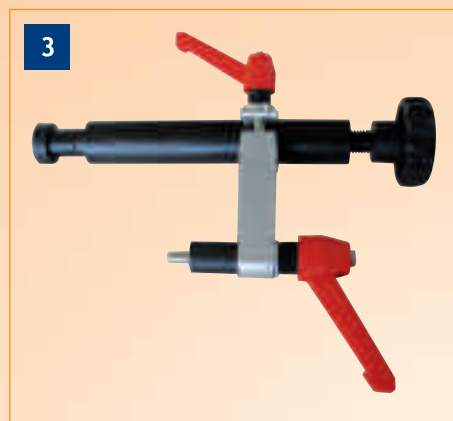

3
- MORSA MANUALE PER SERIE R 300 - F 315
- MANUAL CLAMP FOR R 300 - F 315

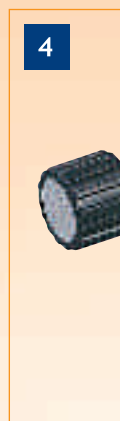

4

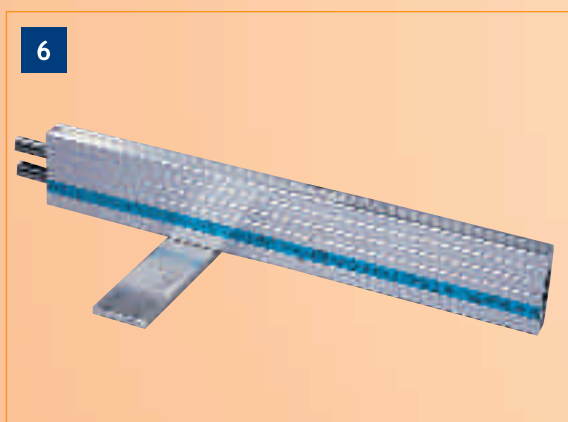

6
- PROLUNGA SQUADRA (LUNGHEZZA A RICHIESTA)
- FENCE EXTENSION (LENGTH ON REQUEST)



7
- FERMO RIBALTABILE
- SLIDING STOP



8
- CAVALLETTO PER PROLUNGA
- SUPPORT FOR FENCE



10A
10
- SACCO RACCOLTI SEGATURA PER BASE ASPIRANTE GPS
- SAWDUST COLLECTING BAG FOR DUST COLLECTION MOD. GPS
- SACCO RACCOLTI SEGATURA PER TRONCATRICI - 10
- SAWDUST COLLECTING BAG FOR CIRCULAR MITRE SAW

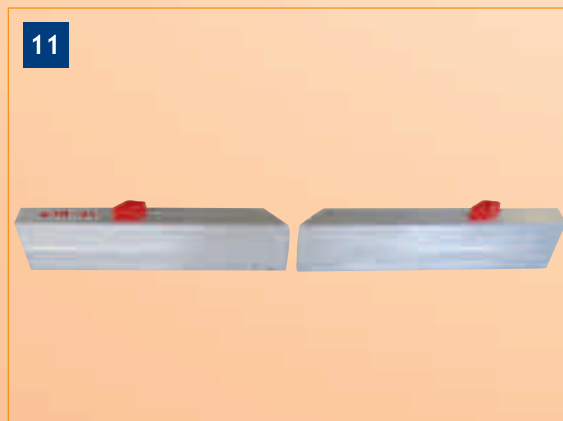

11
- COPPIA PROFILO BREVETTATO PER SERIE MOD. R 300 - F 315
- ECOM300 - ECOM14
- PATENT COUPE PRORILE R 300 - F 315 - ECOM300 - ECOM14

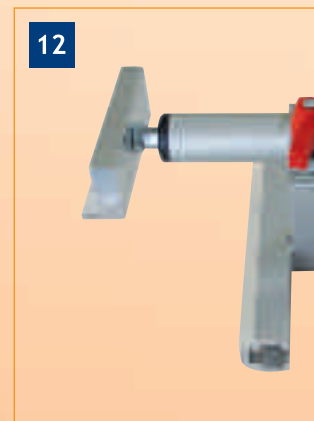

12
- N° 1 MORSA ORIZZONTALE
MANUALE PER CORNICI
- N° 1 MANUAL HORIZONTAL
CLAMP FOR FRAME

PEGGIC PEGG

ONAL



- MORSA MANUALE PER SERIE ECOM 300 -
- ECOM 14 - GP 300 RT - GP 350 RT
- MANUAL CLAMP FORECOM 300 -
- ECOM 14 - GP 300 RT GP 350 RT



5

PER TUTTI I MODELLI
FOR ALL MODELS

- N° 2 MORSE PNEUMATICHE
- N° 2 PNEUMATIC CLAMPS



5A

- N° 2 MORSE PNEUMATICHE
- N° 2 PNEUMATIC CLAMPS
PER TUTTI I MODELLI
FOR ALL MODELS

- N° 2 MORSE PNEUMATICHE CON
LUBRIFICAZIONE DELLA LAMA (SOLO
MOD. GP 300 RT e MOD. GP 350 RT)
- N° 2 PNEUMATIC CLAMPS WITH BLADE
LUBRIFICATION (ONLY MOD. GP 300
RT and MOD. GP 350 RT)

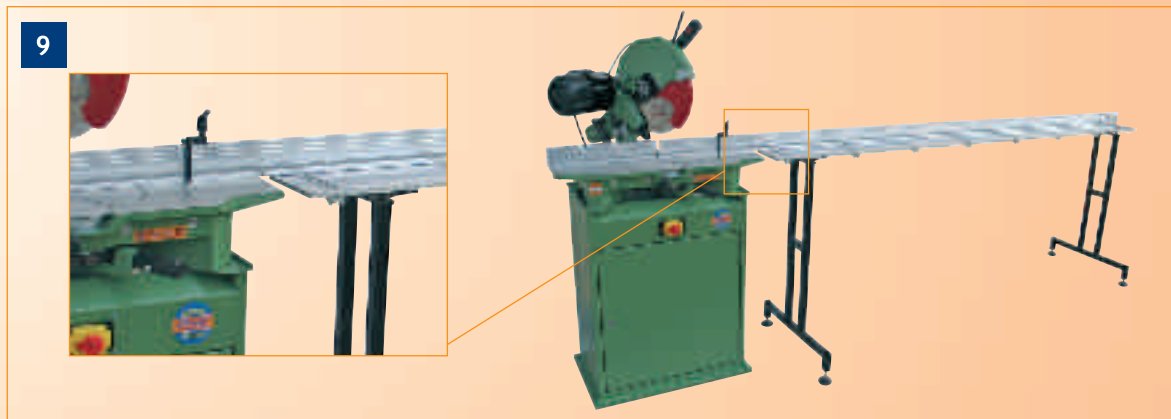

9

- RULLIERA COMPLETA DI PIEDI (LUNGHEZZA A RICHIESTA MIN. MT 1,00)
- LOADING ROLLER WITH SUPPORT (LENGHT ON REQUEST MIN. MT 1,00)

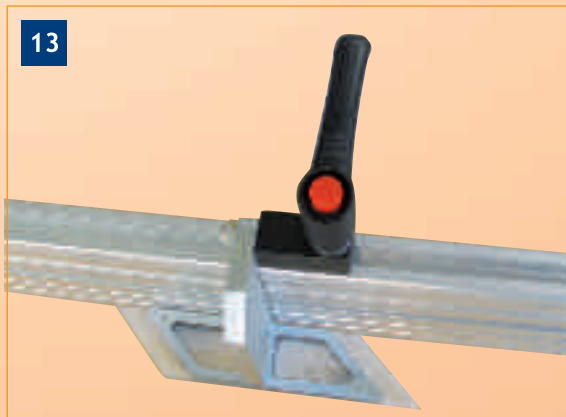

13

- N° 1 FERMO RIBALTABILE PER CORNICI
- N° 1 SLIDING STOP FOR FRAME

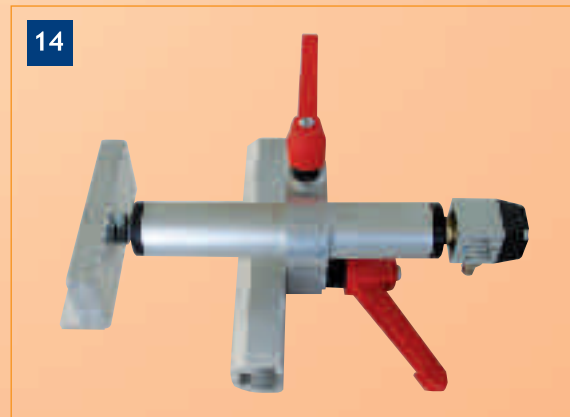

14

- COPPIA MORSE ORIZZONTALI PNEUMATICHE PER CORNICI
- COUPLE PNEUMATIC HORIZONTAL CLAMP FOR FRAME



PEGIC di Ronchetti & C. s.n.c.
Costruz. Macchine per Legno - Alluminio - Pvc
Via Dei Barrocciai, 21 - 41012 CARPI (MO)
Tel. 059/6311112 - Fax 059/650309
www.pegic.it - pegic@pegic.it